

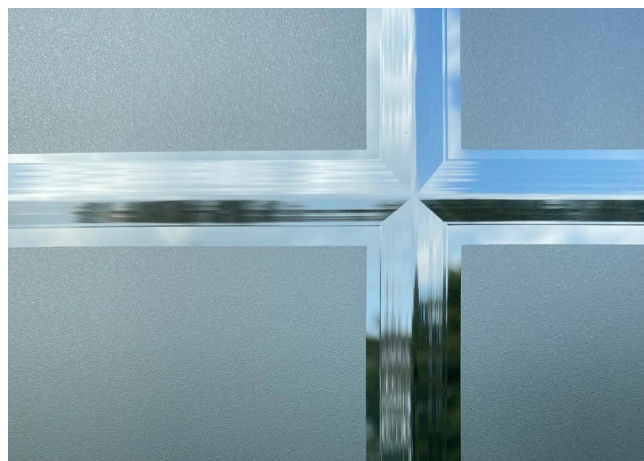

# The Ultimate Composite Door Collection





## Key characteristics of the Ultimate Collection Composite Door slab



An Ultimate Collection Composite Door is more energy efficient than either a PVC panelled door or a solid timber door. Quite simply, The Ultimate Collection Composite Doors outperform all of these alternatives. Traditional or modern, our state of the art core design creates doors which are stronger, more secure and more energy efficient. An Ultimate Collection Composite Door will not split, warp or crack. The core is massively strengthened to resist attack by a strategically positioned polypropylene board. Unlike solid timber doors, this is intelligently encased and positioned within the heat retaining foam core, yet uniquely protected from the elements and potential for damage from water ingress. The Ultimate Collection has 55 composite door styles to choose from. The great benefit of owning our very own paint plant also means Sliders UK can also provide any Ultimate Collection Composite Door in any of the 2530 RAL colour options!

### 1. Polyvinyl Chloride Frame

This water-resistant pure PVC polymer inner frame encases and protects all the inner materials. Ultimate Collection doors eliminate water ingress will not bulge or rot.

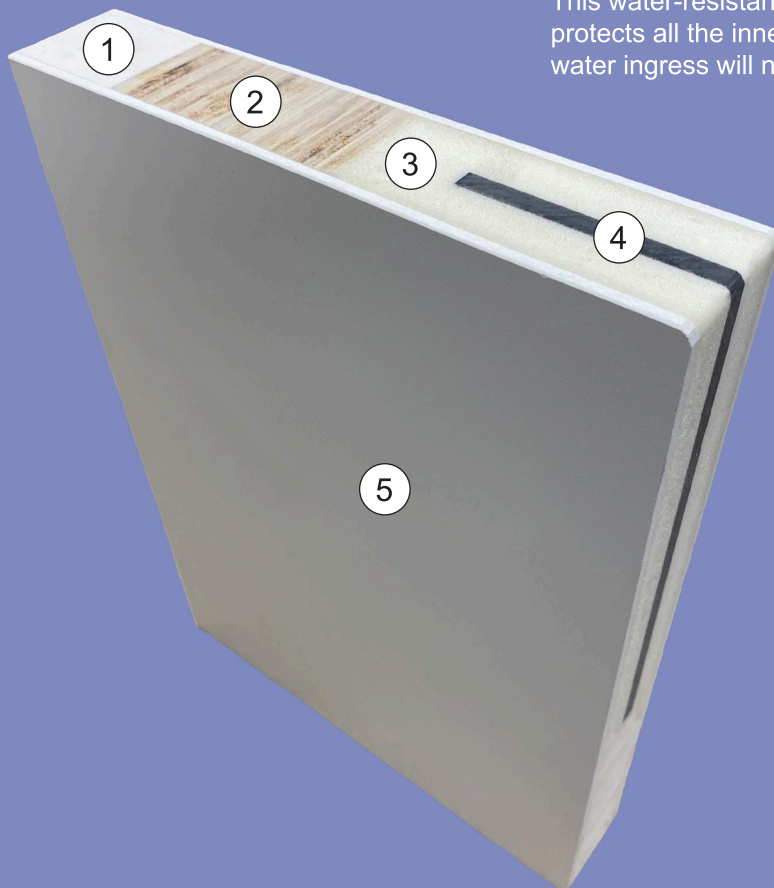

### 2. Timber Layers

The Laminated Veneered Lumber reinforces the door creating a solid dense structure that provides support throughout the door slab.

### 3. Polyurethane Foam

Every Ultimate Collection door has a high-density polyurethane foam core. Each door is engineered to have the best flowability of foam. This is critical for the performance of a GRP door and reduces voids, bulging, uneven surfaces and assists the door with heat retention.

### 5. Glass Reinforced Plastic

The GRP skin provides high resistance to peeling, flaking, cracking, splitting, fading, denting, warping, bowing and twisting, making an Ultimate Collection door extremely durable.

### 4. Polypropylene Board

Designed to create less areas of vulnerability compared to the majority of other entrance doors, which improves the security of an Ultimate Collection door and also increases the difficulty of cutting through the door.

# Data Sheet

Door Style	Eurocell Frame		Duraflex Frame	
	Doorset Min	Doorset Max	Doorset Min	Doorset Max
Craftsman	862	1024	848	1010
Dual Glazed / Arch	862	1024	848	1010
4 Panel Solid	834	1024	820	1010
Tops & Mids	862	1024	848	1010
Tops	834	1024	820	1010
6 Panel Solid	834	1024	820	1010
Half Moon Mids	862	1024	848	1010
Half Moon	834	1024	820	1010
3 Quarter Glazed	862	1024	848	1010
Half Glazed	862	1024	848	1010
Half Glazed Arch	862	1024	848	1010
Full Glazed	862	1024	848	1010
Cottage - All	820	1024	806	1010
Flush - All	820	1024	806	1010
Cottage Framed - All	834	1024	820	1010
Centre Glazed	820	1024	806	1010
Longlite	820	1024	806	1010
Modern	862	1024	848	1010
3 & 4 Top	820	1024	806	1010
5 Top Round	820	1024	806	1010
Morse	820	1024	806	1010

Threshold	Min	Max	Depth
<b>Duraflex</b>			
Std PVC	2009mm	2119mm	68mm x 48mm
Low PVC	1979mm	2089mm	38mm x 18mm
Low Ali	1969mm	2079mm	15mm 7mm

Threshold	Min	Max
<b>Eurocell</b>		
Std PVC	2023mm	2133mm
Low PVC	2008mm	2118mm
Low Ali	1976mm	2086mm

**PLEASE NOTE:**  
If including a cill,  
include 30mm for the cill  
within your total height.

# Outer Frame and Cill

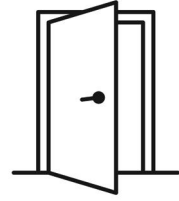

**Duraflex Ovolo  
Frame Profile**



**Eurocell Bevelled  
Frame Profile**



**Duraflex Ovolo  
Top & Side Light  
Profile**



**Eurocell Bevelled  
Top & Side Light  
Profile**

**Duraflex Cill Options**

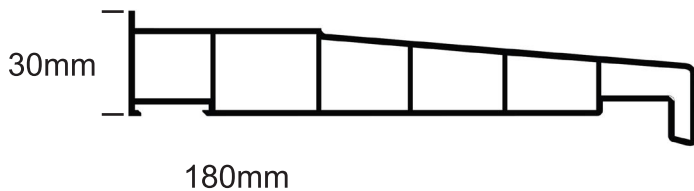
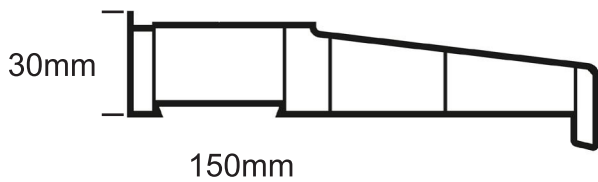
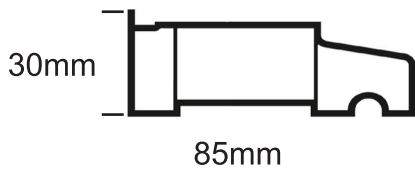

**Eurocell Cill Options**

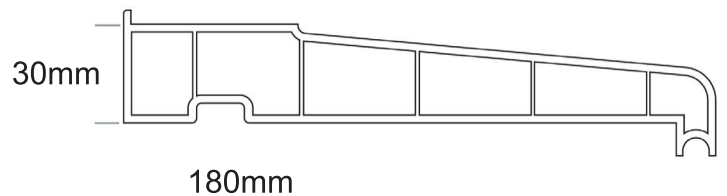
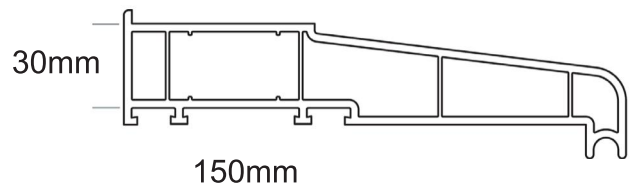
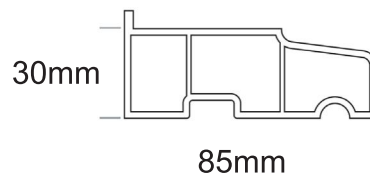

# Threshold Options

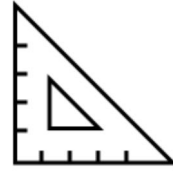

**Eurocell Standard Threshold**

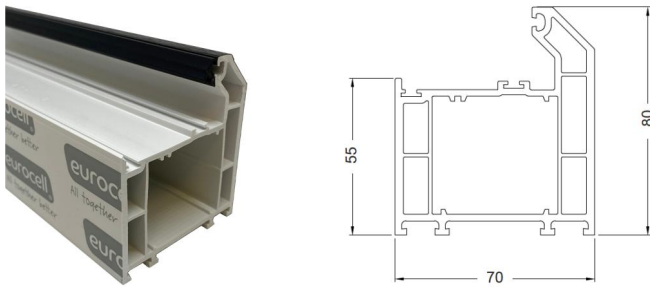

**Duraflex Standard Threshold**

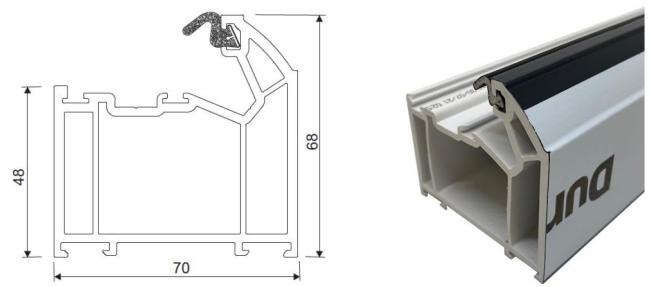

**Eurocell Medium Threshold**

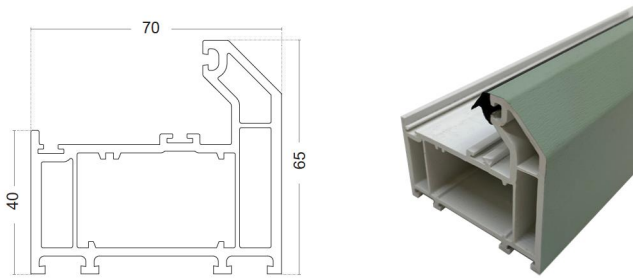

**Duraflex Low PVC-U Threshold**

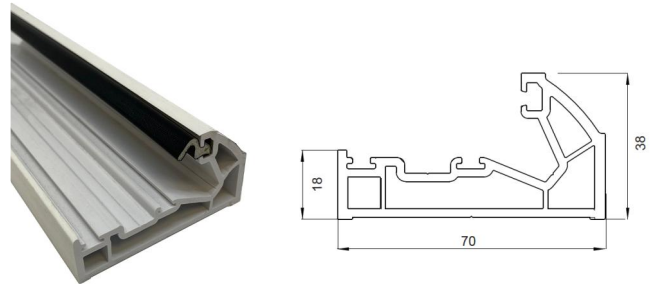

**Stormguard Low Aluminium Threshold and optional ramp**

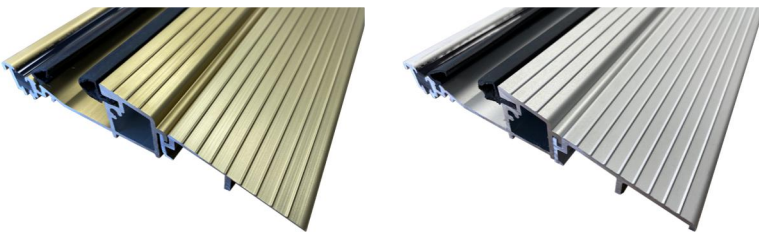

**Exitex Aluminium Low Threshold**

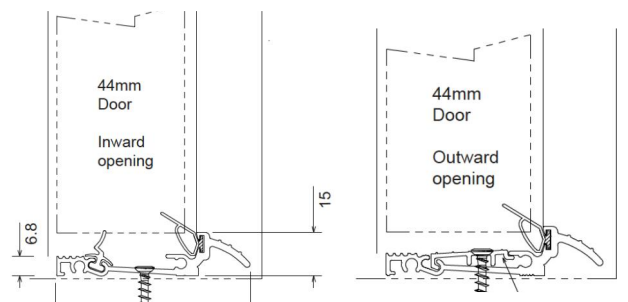
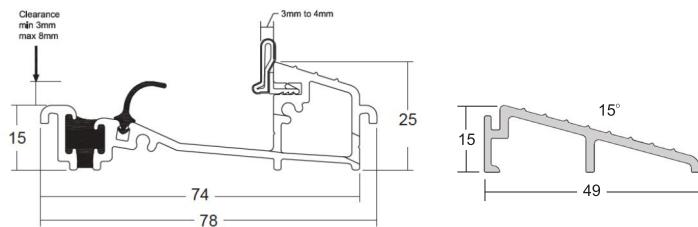
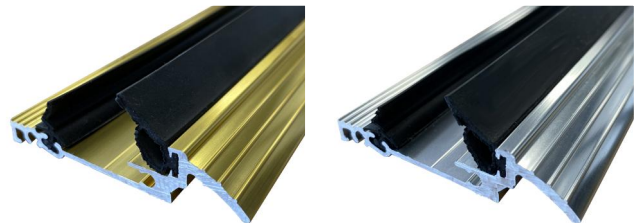

# APECS 3\* Cylinder and Ingenious Lock



We are confident in the exceptional strength that the APECS AP and the ILH Duplex Lock offer when used together, that we are offering a break in guarantee of up to £5000 for your maximum peace of mind (T&Cs apply).

**THIS MEANS THAT IF ONE OF THESE PRODUCTS FAIL AS A RESULT OF A BREAK IN, WE WILL GIVE YOU UP TO £5000 COMPENSATION.**



4. Anti-plug extraction

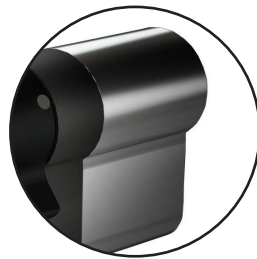

3. Operable from internal side when lock is tampered with externally



5. Drilling attack resistance: Hardened Steel pins in the cylinder core and body



6. Hardened Steel cam protection block prevents the cylinder from snapping and plug extraction



7. Interlocking mechanism engages with the cam to protect the cylinder when the external part is snapped

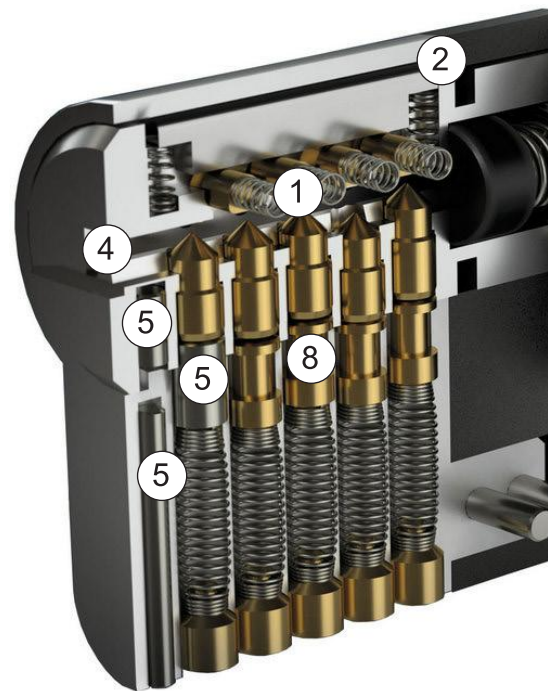

8. Anti-pick protection  
Special grooves





AVAILABLE AS  
KEY-THUMB TURN

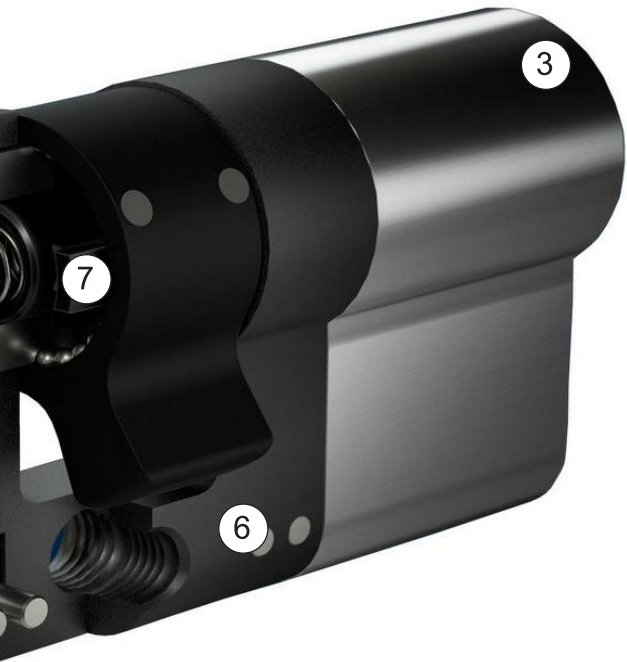
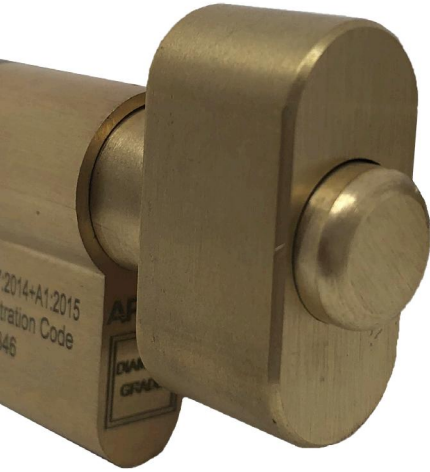

2. Snap secure  
sacrificial point

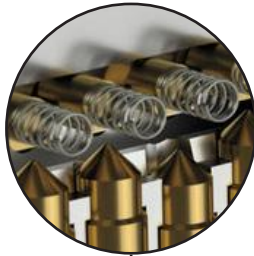

1. Double locking mechanism  
with track pins protects on  
several security  
levels and safeguards from  
bumping and picking



ection:  
d pins

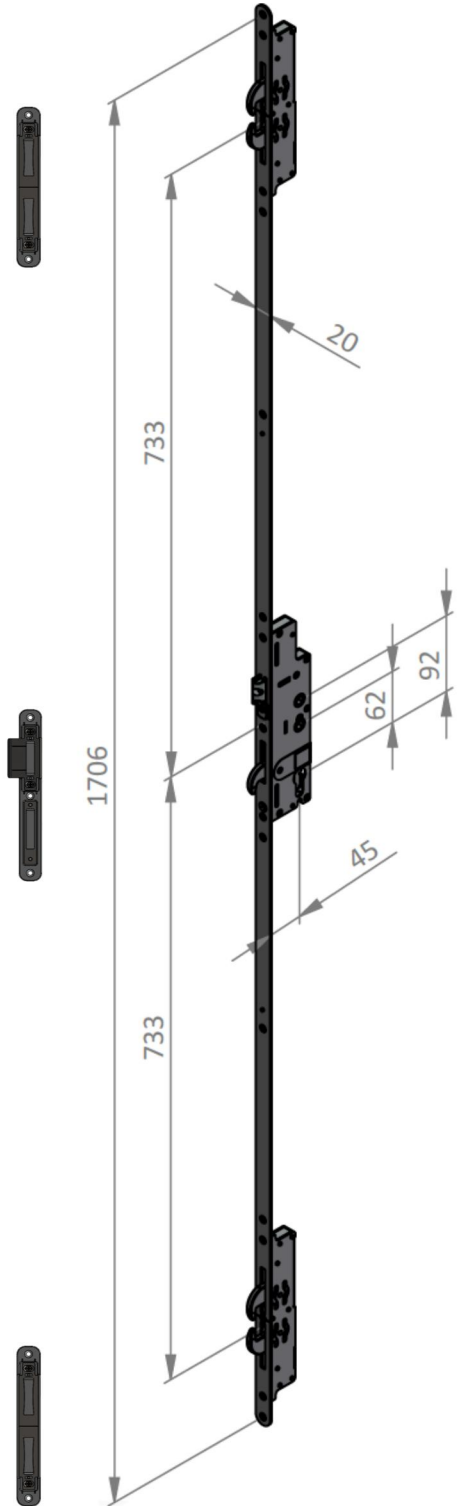

# Ancillaries



## Frame Add-on Options:

**Eurocell 15mm Add-On**

**Duraflex 15mm Add-On**

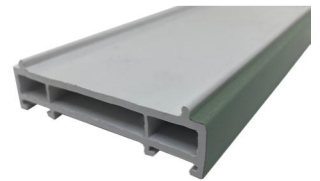
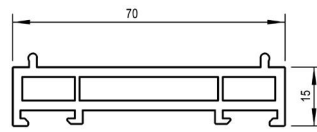
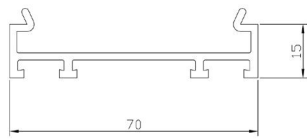

**Eurocell 25mm Add-On**

**Duraflex 35mm Add-On**

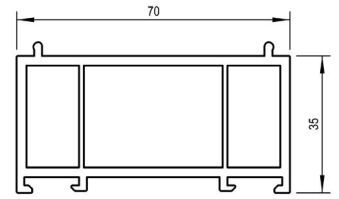
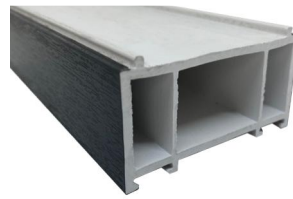
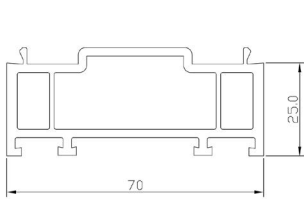

**Eurocell 50mm Add-On**

## Couplers

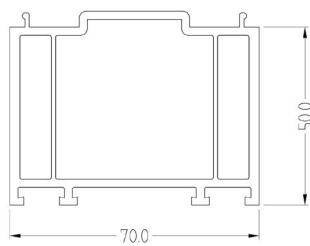

**Eurocell**

**Duraflex**

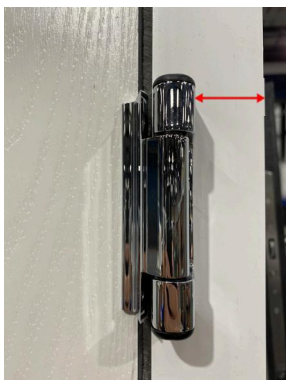
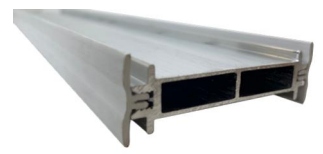
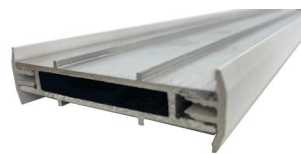

**Eurocell outerframe is 33mm from the frame side of the hinge to the outside of the frame**

**Duraflex outerframe is 27mm from the frame side of the hinge to the outside of the frame**





# Decorative Glass

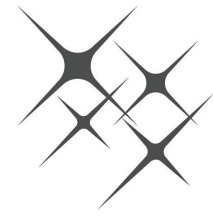

All decorative glass units are 26mm thick

Toplight and sidelights are 28mm thick

TOPS - 203 X 152

HALFMOON - 549 X 250 (Halfmoon shape)

MIDS - 203 X 605

DUAL - 203 X 914

HALF GLAZED - 558 X 914

HALF GLAZED ARCH - 558 X 914 (Arched head)

DIAMOND / SQUARE - 190 X 190

LONGLITE - 177 X 1625

FULL GLAZED - 558 X 1625

THREE QUARTER GLAZED - 558 X 1219

CRAFTSMAN - 587 X 356 (Curved head)

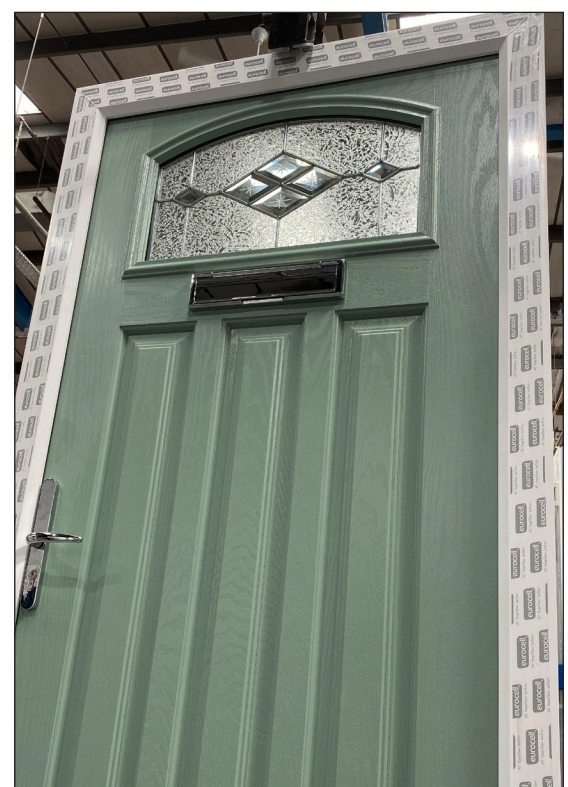
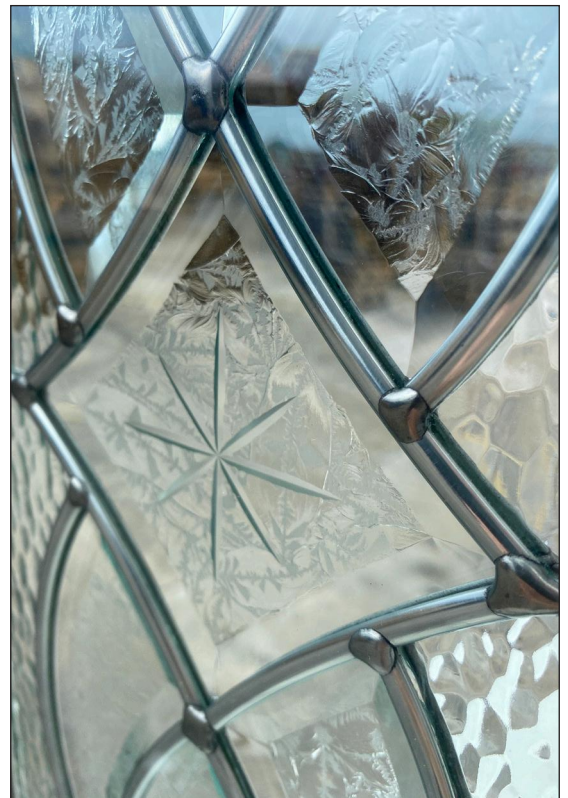

# Decorative Glass Options

The Ultimate Collection has an eclectic range of decorative glass. Whether your taste and choice is traditional or contemporary, there's an Ultimate Collection composite door to suit any home.

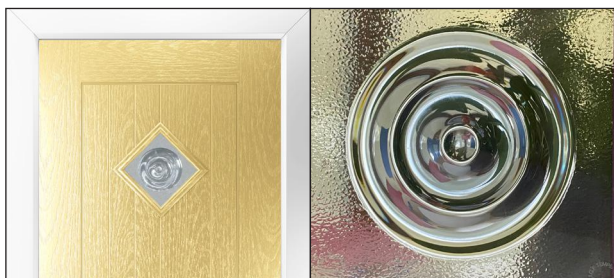

## Bullion

Deeply carved rings refract the light with stunning effect. Unlike traditional bullions these opulent grooves are encapsulated within the insulated glass unit for ease of cleaning.

Decorative Type	Glass Detail	Glass Textures
Double Glazed Bullion	Deep cut encapsulated bullion	Stipple / Clear Bullion

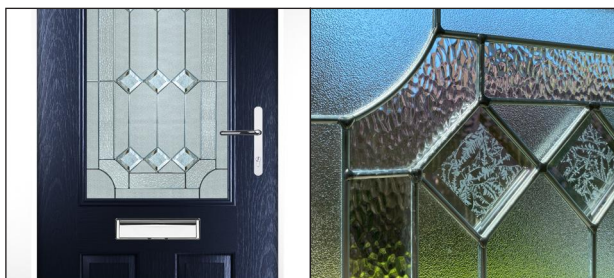

## Cameo

An extremely popular option 'Cameo' is a triple glazed decorative panel featuring crystal cut glass bevels. Backing textures have been carefully selected to compliment some of the most popular backing glasses used in side panels or top lights.

Decorative Type	Glass Detail	Glass Textures
Triple Glazed Bevel	Cut bevel design with zinc came	Stipple / Mins / Gluechip Bevel



## Crescent

Strikingly modern the 'Crescent' is a bespoke model which combines an etched finish with a graduated clear motif. The design is encapsulated within the insulated unit to ensure its good looks are well protected for many years to come.

Decorative Type	Glass Detail	Glass Textures
Double Glazed Frosted	Frosted background with clear dividing lines	Clear / Frost (etch / sandblast)

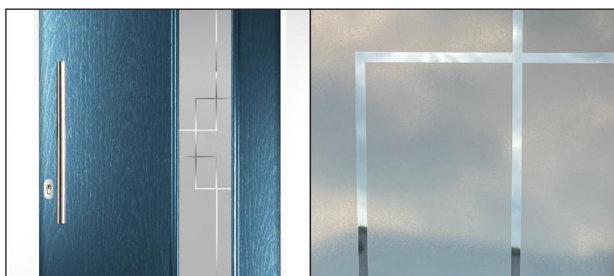

## Deco

This linear design combining a satin effect backing glass and clear lines, offering a look of the utmost sophistication. Visually this style is very clean and crisp.

Decorative Type	Glass Detail	Glass Textures
Double Glazed Frosted	Frosted background with clear dividing lines	Clear / Frost (etch / sandblast)



## Edge

This well-known design is simple and elegant, working very well both in traditional and contemporary properties. Edge decorative glass combines a satin effect backing with clear dividing lines.

Decorative Type	Glass Detail	Glass Textures
Double Glazed Frosted	Frosted background with clear dividing lines	Clear / Frost (etch / sandblast)

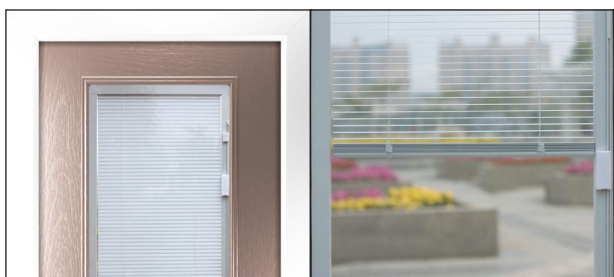

## Integral Blinds

The integral blind is cleverly encapsulated within the insulated glass cavity of this door to provide a zero maintenance blind. The blind can be raised, lowered and easily tilted using the unobtrusive finger control on the edge of the frame.

Decorative Type	Glass Detail	Glass Textures
Double Glazed	Adjustable blind between glass	Clear





### Grace

This lavish bevel cluster refracts light beautifully, with zinc came and hammered effect backing glass. It is a real statement piece. Available with Dual Glazed, Centre Glazed, Morse, Half Glazed and Half Glazed Arch door styles.

Decorative Type	Glass Detail	Glass Textures
Triple Glazed Bevel	Cut bevel design with zinc came	Gluechip / Mins



### Polaris

This beautiful star sparkles with light. Bevels with zinc came, surrounded with a stipple effect that provides moderate levels of privacy. Available with Tops and Mids, Half Moon and Mids, Cottage/Cottage Framed/Flush/Stable - Short, door styles.

Decorative Type	Glass Detail	Glass Textures
Triple Glazed Bevel	Cut bevel design with zinc came	Stipple

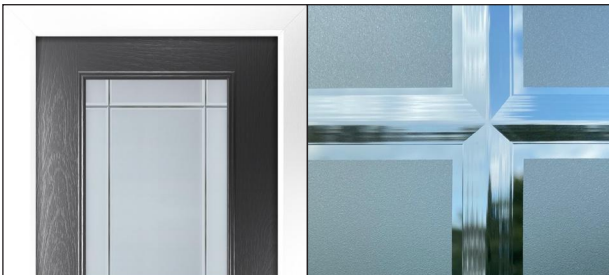

### Nordic

This very clean option has a brilliant-cut bevel to its outer face with a very smooth sandblasted surrounding backing glass. The sandblast highlights particular well the deeply grooved clear channels

Decorative Type	Glass Detail	Glass Textures
Double Glazed Frosted	Frosted background with clear dividing lines	Clear / Frost (etch / sandblast)

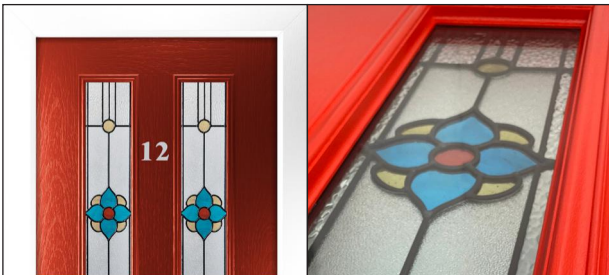

### Oasis

A wonderful traditional stained glass design with the modern twist of being triple glazed. This vibrant model combines colourful antique look cut glass with aged black came. Ideal for period and character properties.

Decorative Type	Glass Detail	Glass Textures
Triple Stained Glass	Antique coloured glass with black came	Stipple / Colour / Mins

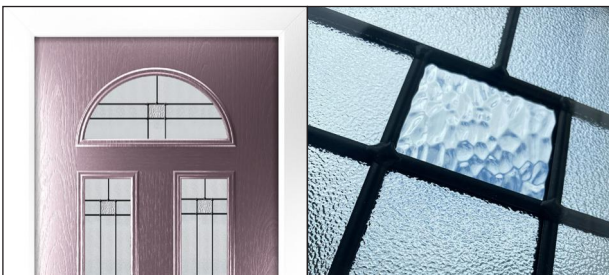

### Tate

Triple glazed decorative design at its very best! Black came, cut hammered and stipple backing textures give a lovely, graceful look. Due to high demand this choice is featured in most door styles.

Decorative Type	Glass Detail	Glass Textures
Triple Glazed Bevel	Cut bevel design with black came	Stipple / Mins

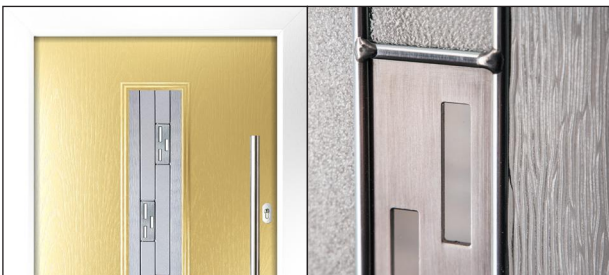

### Tri Line

Ultra-modern triple glazing with amazing laser cut polished stainless-steel inserts. 'Tri Line' is a real showstopper, is aesthetically stunning and perfect for the contemporary door.

Decorative Type	Glass Detail	Glass Textures
Triple Stainless Steel	Laser cut stainless steel with zinc came	Stipple / Cots

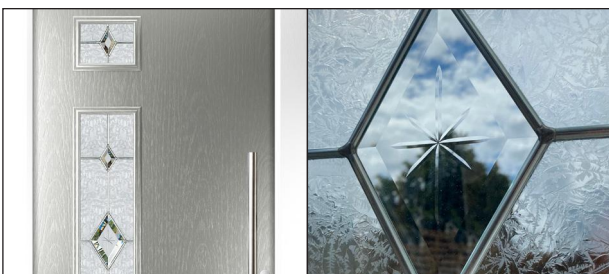

### Trio Diamond

Trio Diamond is characterised by its distinctive diamond cut bevels with brilliant cut starbursts to their centre. Triple glazed with zinc came and glue chip backing.

Decorative Type	Glass Detail	Glass Textures
Triple Glazed Bevel	Cut bevel design with zinc came	Gluechip



# Installation Tips



## Changing the decorative or textured glass



Insert a flat headed screwdriver into the prising slot and gently twist clockwise until the internal cassette starts to come away.



Remove the screws and inner mid piece. Ensure the glass is supported and does not drop out.

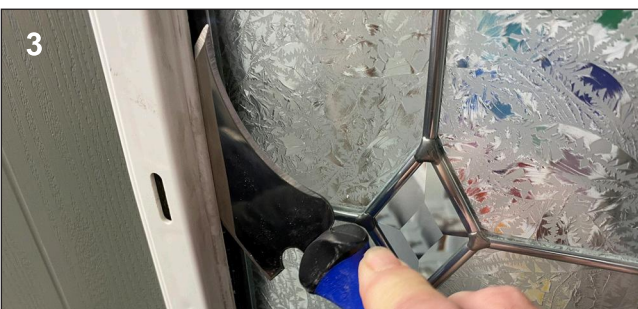

Use a moon knife to separate the glass from the gel tape on BOTH internal and external sides. Remove all original gel tape and ensure the area is clean.



Remove all original gel tape and place new gel tape around the internal cassette.



Place new gel tape around the retaining external cassette, remove the gel tape cover and gently position the glass against the external cassette.



Fix the inner mid piece into position and insert all screws. Clip the outer cassette onto the inner mid piece.



Every Ultimate Collection door is fully wrapped and includes our installation guides. Use a tablet or smart phone camera to scan the QR code. The QR code provides you with a PDF guide or a short installation film. Find out how to ensure a level line, smoothly connect top, side and fan lights, plus many more helpful and essential fitting tips.

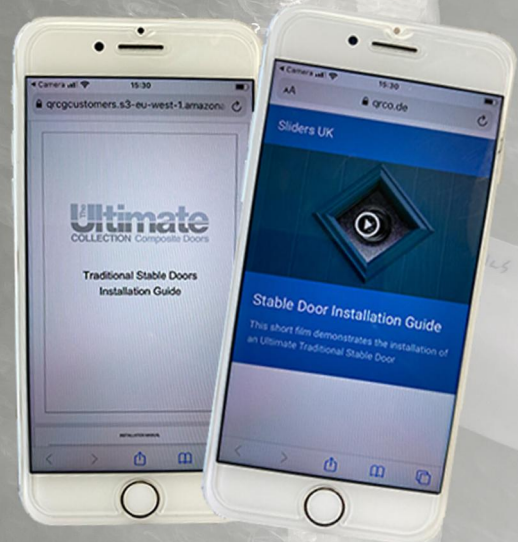

#### COMPOSITE DOORS



#### COMPOSITE STABLE DOORS



# Ingenious 2D Adjustable Door Hinge



The Ingenious 2D Hinge is adjustable both vertically and horizontally.  
(Remove top and bottom covers '1 & 2' to conduct vertical adjustment)

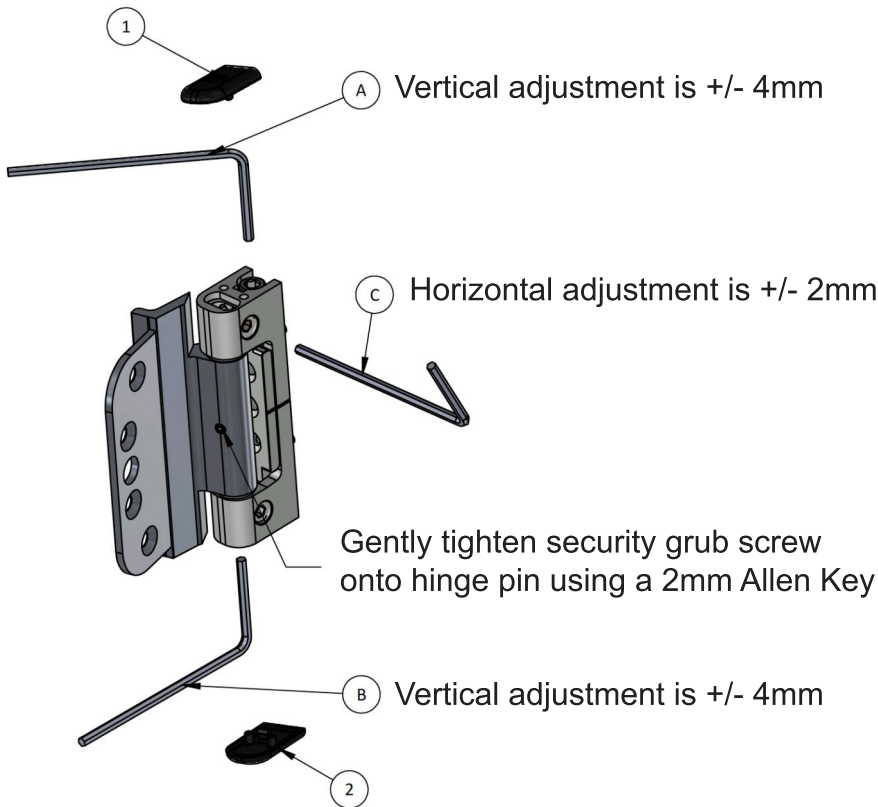

- PAS 24 COMPLIANT
- DOG BOLT ATTACHMENT AVAILABLE

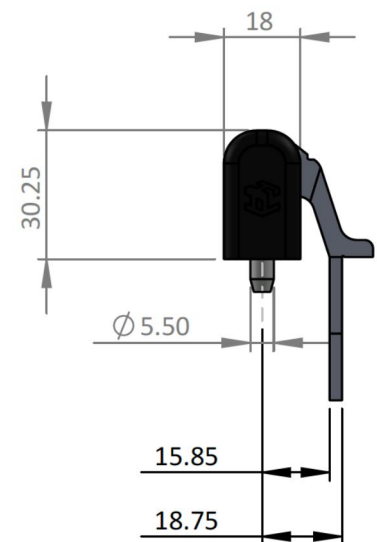

- **To adjust vertically upwards**

Firstly slacken the bottom most adjustment screw using a 5mm Allen Key 'B' the desired distance. Secondly tighten the top most adjustment screw until tight.

- **To adjust vertically downwards**

Firstly slacken the top most adjustment screw using a 5mm Allen Key 'A' the desired distance. Secondly tighten the the bottom most adjustment screw using a 5mm Allen Key 'B' until tight.

- **To adjust horizontally**

Rotate the two side adjustment screws anti-clockwise or clockwise using a 4mm Allen Key 'C' until the desired distance is achieved.

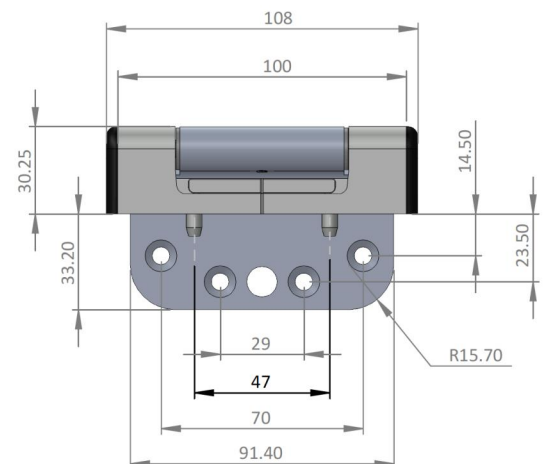





# The Ultimate Composite Door Collection

- LEAD TIME OF 3-4 WEEKS
- CONTAINER STOCK & CONSTANT SUPPLY
- 55 DOOR STYLES
- UNIQUE BROCHURE
- WE SUPPLY OVER 350 DOORS PER WEEK
- MULTIPLE HARDWARE OPTIONS
- VARIED GLASS RANGE
- SLAB COLOUR MATCH DOOR FRAMES
- DOUBLE DOOR OPTIONS
- STABLE DOOR OPTIONS
- OVER 2530 RAL COLOURS TO CHOOSE FROM
- ONLINE QUOTATION / ORDER PORTAL
- FULLY PACKAGED



# The Ultimate Composite Door Collection

## High precision manufacture

We employ the strictest quality management system. Every door is fully inspected, wrapped and delivered by our dedicated fleet, allowing us to offer you guaranteed quality and service.

*Images shown are for illustration purposes only*

OCT2022

