

The Ultimate

EvoSlide ALUMINIUM PATIO DOORS

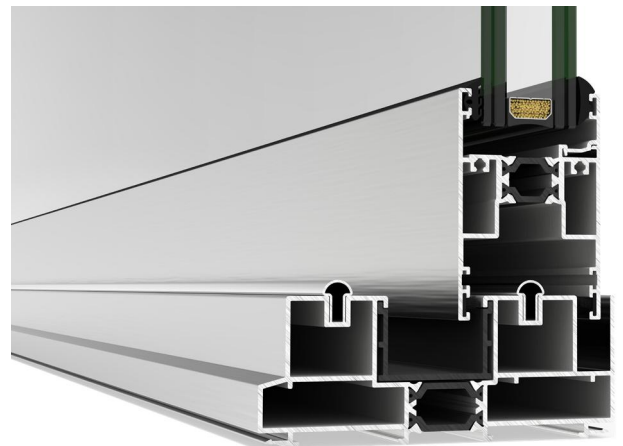





Cutting-edge innovation with ultra slim sightlines

ENJOY SMOOTH OPERATION, LASTING QUALITY AND A BRIGHTER, MORE SPACIOUS HOME WITH THE ULTIMATE EVOSLIDE

The Ultimate Evoslide Sliding Doors deliver the best in modern styling and contemporary flair. Premium sliding doors with slim flat sightlines, that effortlessly glide along its robust stainless steel rails. The Ultimate Evoslide operates from top-end hardware and has an eclectic colour range, this includes a standard choice of Grey 7016, White and Black which have short lead times.

Choose either two, three, four or six sashes of up to 280kg weight, allowing maximum dimensions of 2500 (Width) and 3000 (Height) mm per sash – The Ultimate Evoslide Sliding Doors allow for outstanding flexibility!

The Ultimate Evoslide Sliding Doors are ideal for both replacement and new projects. The slim lines, low threshold, graceful operation and modern appearance, makes these sliders suitable for any home that desires a practical door system.

**Slim, sleek and
without compromise**

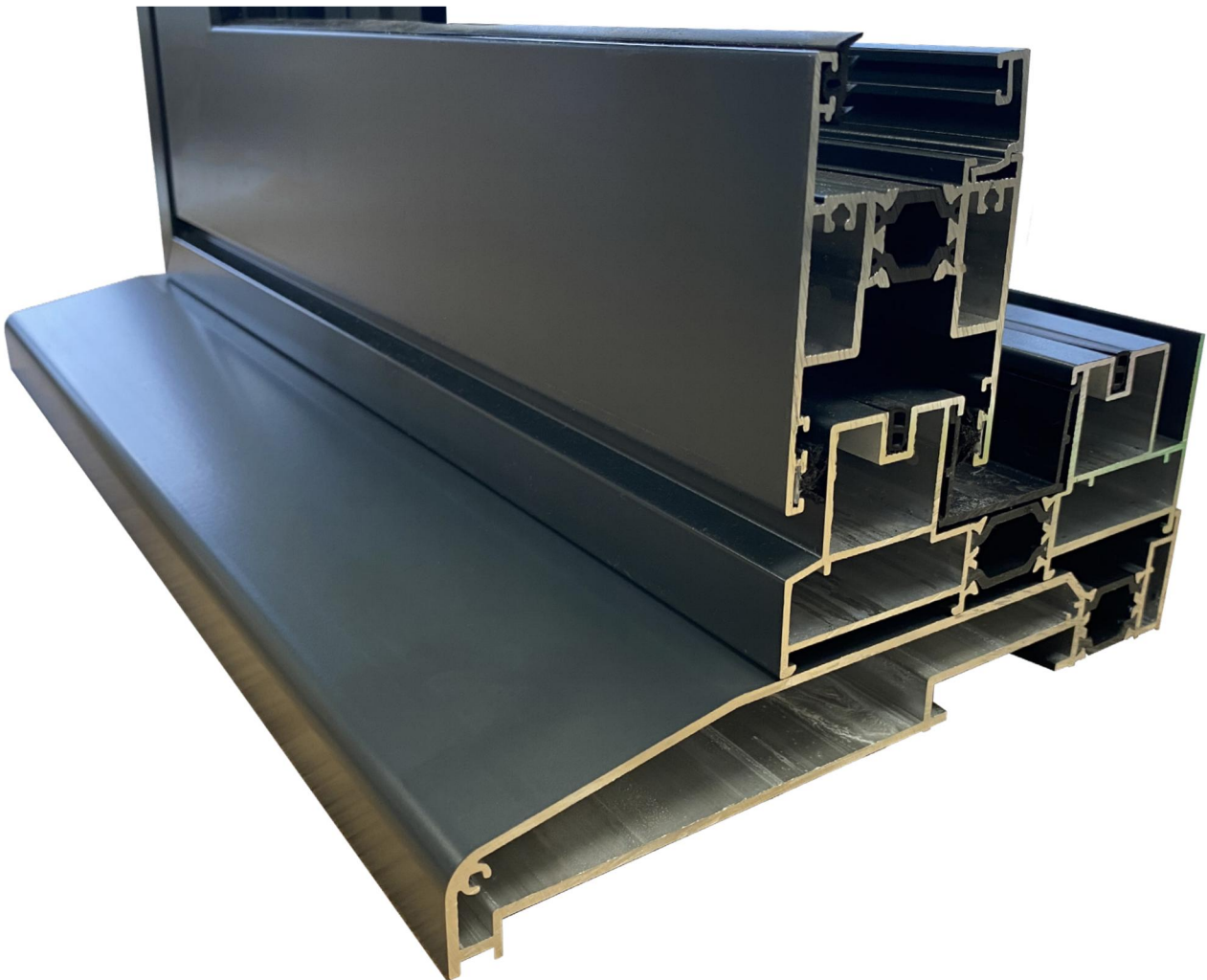

Thermal Insulation

Energy efficiency in buildings is a demand made by architects and homeowners. Both being aware of the importance of a home's environmental footprint. The Ultimate Evoslade meets such challenges with all the latest technological developments necessary to ensure your home remains comfortable whilst aesthetically pleasing.

Categories Achieved at Test Centre

Air permeability (EN 12207):	Class 3
Water tightness (EN 12208):	Class 7A
Wind resistance (EN 12210):	Class C5
Security test PAS24:2016	Passed

Reference test 1.80 x 2.20m / 2 sashes

**Smooth operation
and premium quality**



Advanced Performance

The enclosed systems have been fully tested to guarantee the best performance in watertightness, atmospheric agent resistance, air permeability and wind loads.

Slim Sightlines

The Ultimate Evoslide sliding system incorporates a minimal central joint of only 47mm of frame sightline. This allows glazing capacity up to 34mm, which can provide additional thermal and acoustic benefits.

Parameters Per Sash

Width - Minimum 0.6m Maximum 2.5m
Height - Minimum 1.5m Maximum 3.0m

Maximum Weight/Sash - 280kg

28mm Double or 34mm Triple Glazing

Configurations

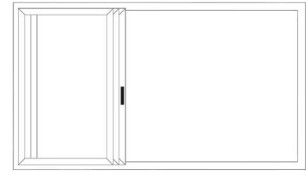

- The direction the door slides



- Fixed pane



- The door slides in both directions

With internal and external sliding sash options, the Ultimate Evoslide offers exceptional design flexibility with 12 different configurations and up to a maximum six individual panels.

Due to transportation weight restrictions, Evoslide Sliding Doors larger than 6000mm in width and/or 2500mm in height, will be delivered in kit form for re-assembly on site.

Externally Viewed

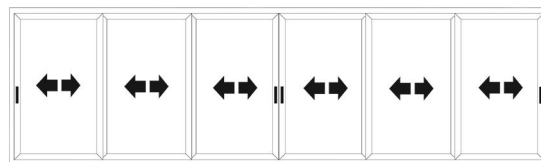
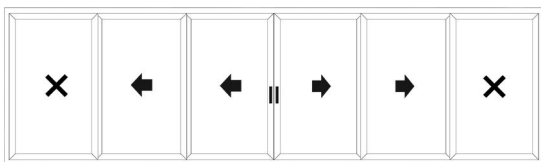
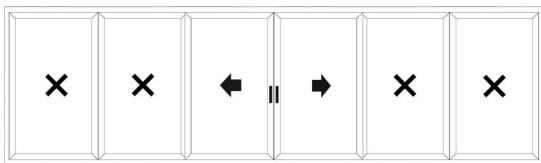
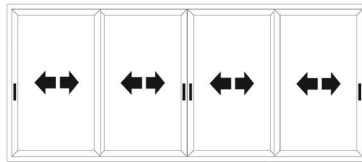
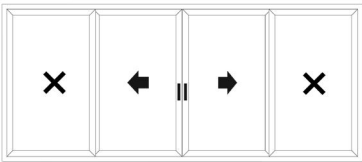
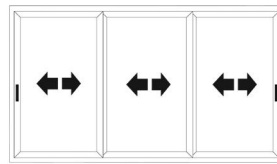
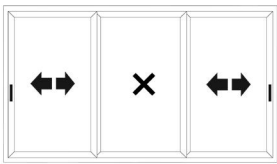
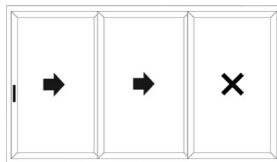
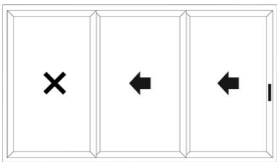
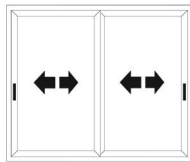
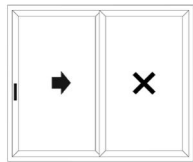
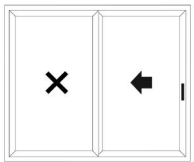

Hardware options



Standard Manilla Offset Handles



White



Grey 7016



Black



Dark Silver

Sobinco Premium Built In Cup Handles



- Key Turn Shootbolt Locking
- High corrosion resistant class 5 (480u - EN1670)
- Durability: BS EN 1906:2012
- White
- Grey 7016
- Black

Sobinco Premium Sliding Pull Handles



- Key Turn Shootbolt Locking
- High corrosion resistant class 5 (480u - EN1670)
- Durability: BS EN 1906:2012
- White
- Grey 7016
- Black

APECS 3* Cylinder (standard with all handle options)

- Double locking mechanism with additional track rail pins
- Interlocking mechanism and hardened cam protection block prevents from snapping and plug extraction
- Ball-bearing connection ensures additional operation smoothness and strong fixing between the cylinder core and the cam
- Operable from inside when lock is tampered with externally

Blu Premium Stainless Steel Pull Bars



- Key Turn Shootbolt Locking
- Contemporary, high quality patio sliding door handle
- Manufactured from 316 Marine Grade Stainless Steel
- Ideal for use where corrosion levels are high, such as coastal environments
- Durability: BS EN 1906, BS 8424
- Lifetime guarantee

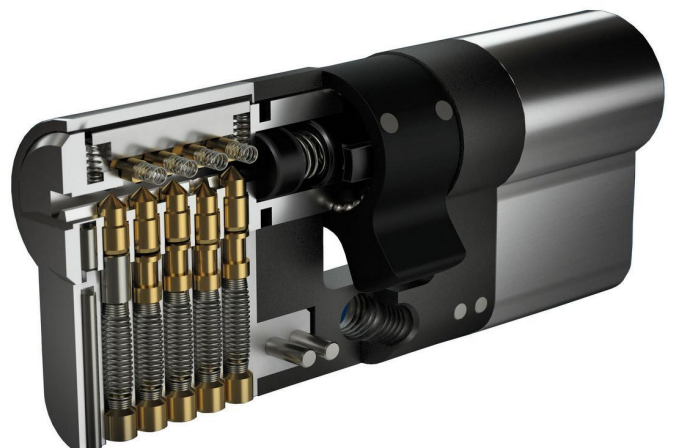

Images are for illustrative purposes only





Uninterrupted view

If having an uninterrupted view is important, then an Ultimate Evoslide door could be the best option. Slim sightlines, with grand door leaves that frame large panes of glass, the Ultimate Evoslide provides a panoramic view of all that is outside.

Images are for illustrative purposes only

Track and Cill



Double Track

The bottom track of The Ultimate Evoslide Sliding Doors is only 47mm high and can be installed 47mm below the finished floor level to provide a fully weathered flush track. If desired, it can be specified with a 180mm or 230mm cill or a 250mm for the triple track options, increasing the drop required below the finished floor to 72mm.

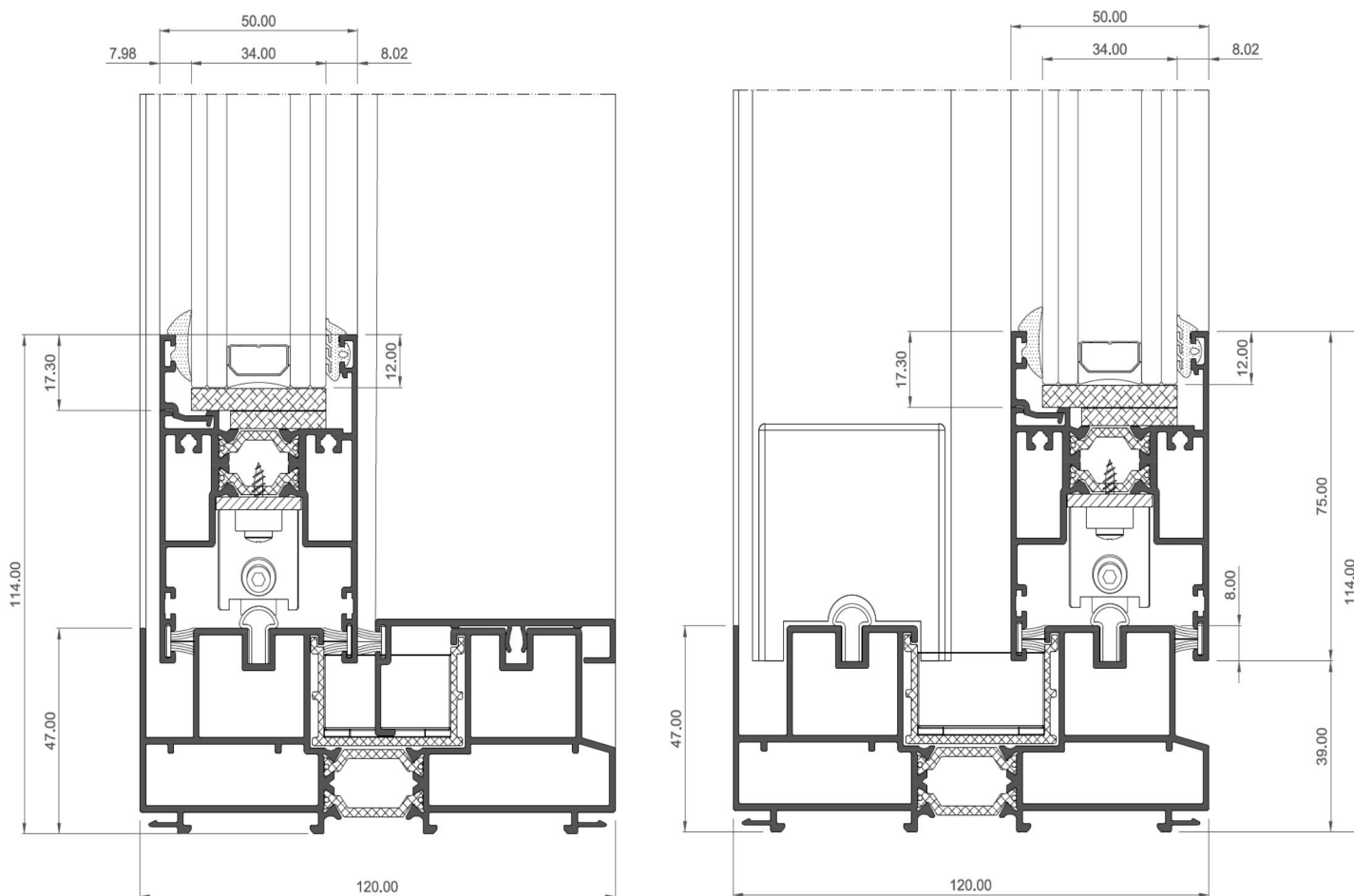

Cill options

A cill is optional. All cill options are 25mm in height. Cills are available in the following depth sizes:

- 180mm
- 230mm
- 250mm (Triple Track)

Triple Track

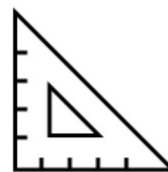

Triple Track

Conventional sliding patio doors often use a single or dual track system, the Ultimate Evoslide patio door range offers a triple track sliding aluminium door. This permits each sliding panel to sit behind the other and provides a much wider opening.

The Ultimate Evoslide aluminium sliding patio doors are a superb alternative to bifold doors. The Evoslide offers wider and unobstructed glass panels that stack gracefully behind each other. Each pane can be up to 2.5 metres wide and as high as 3 metres, allowing natural light to flood into the room.

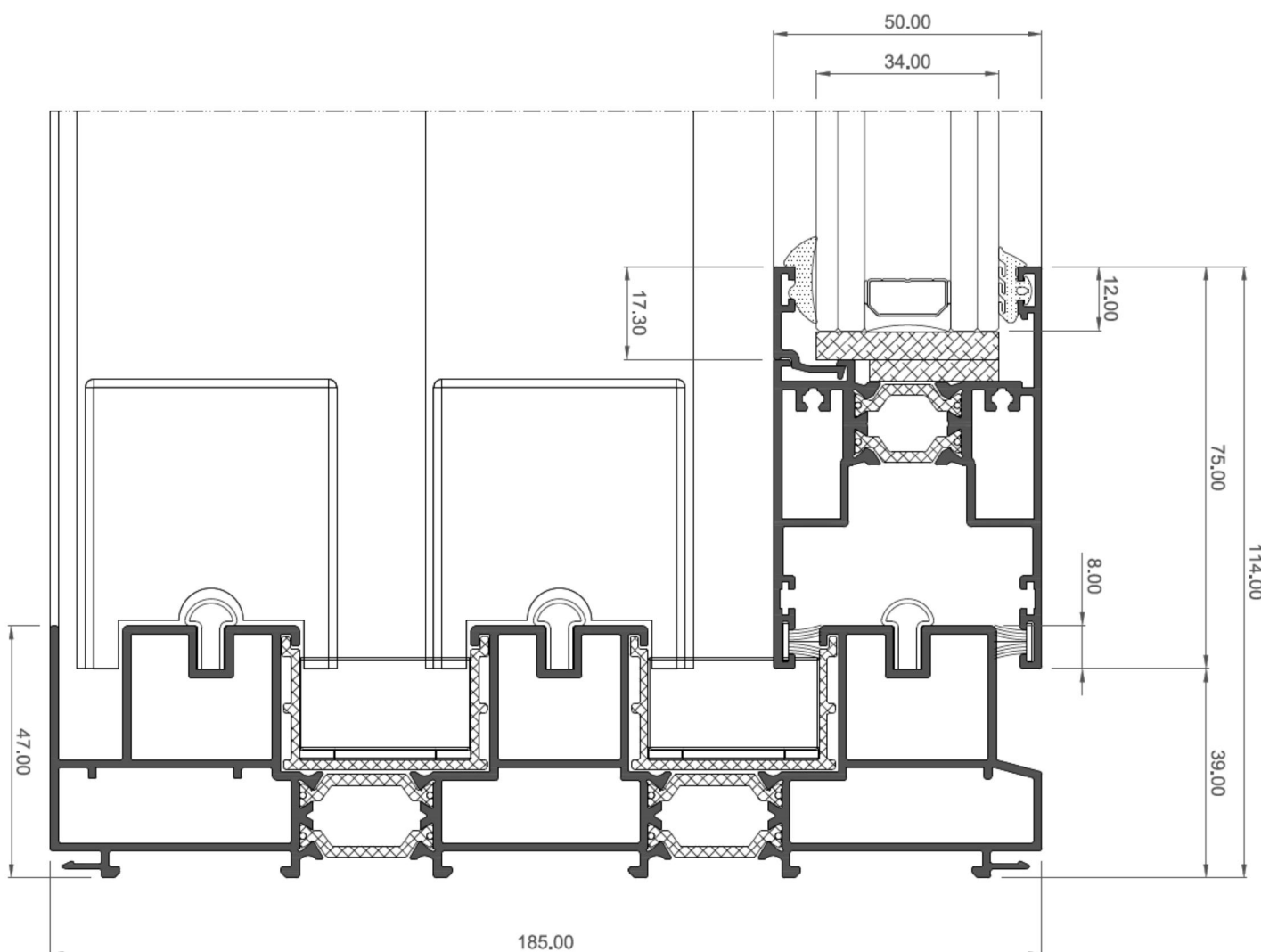

Ultimate Evoslide Aluminium Patio Door Wall Chart

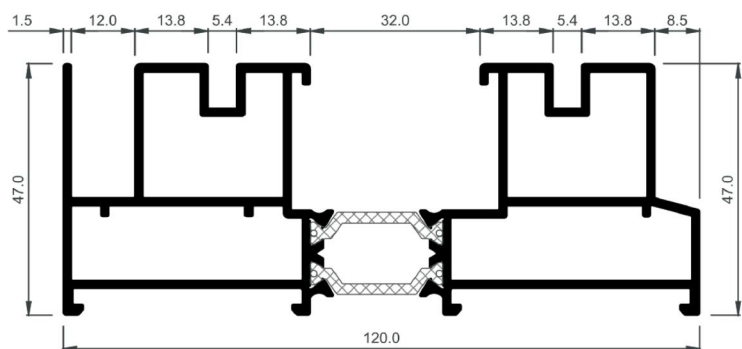

Two rail frame

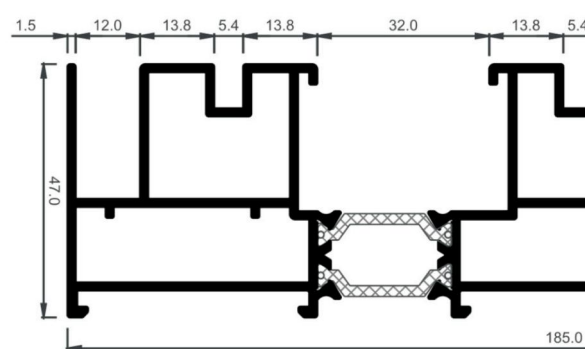

Three rail

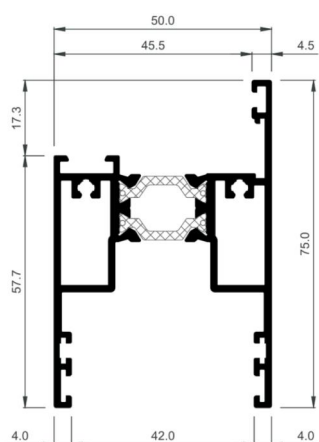

Perimeter sash

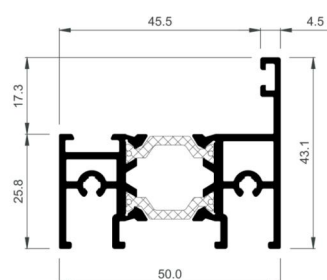

Central sash

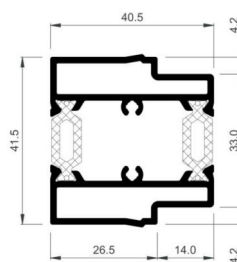

Sash joint profile



Intersection cover

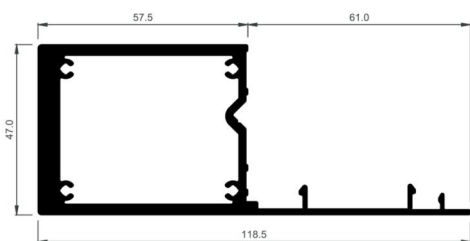

47x57, 5mm reinforcement

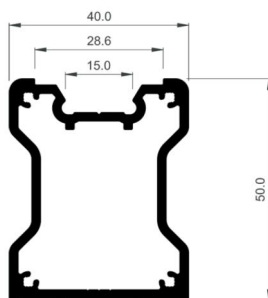

Reinforcement 40x50mm



Frame cover for fixed light

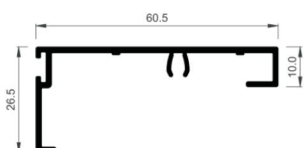

Fixed sash frame cover

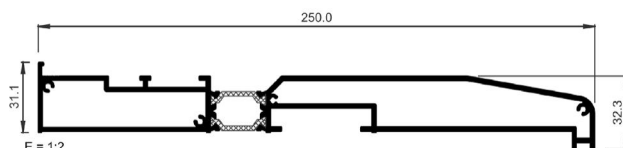

Cill 250mm

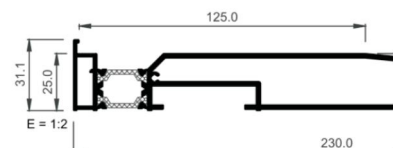

Cill 230mm

The Ultimate

EvoSlide ALUMINIUM PATIO DOORS

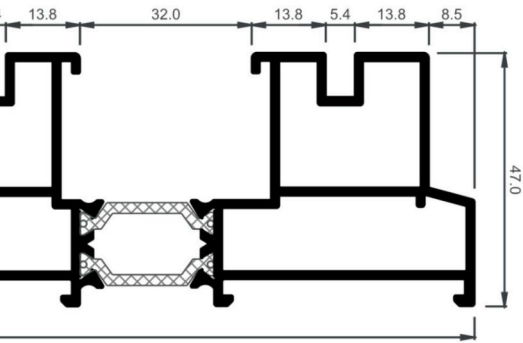

frame

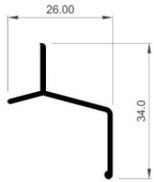

Top rain gutter

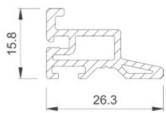

Central sash hem

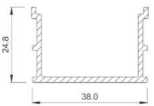

Two rail frame isolation

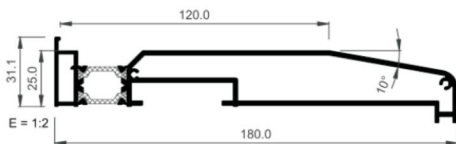
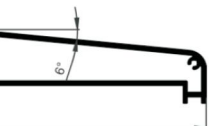

Cill 180mm

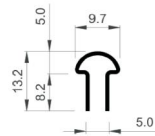

Stainless steel rail



Cover gasket



Channel cap gasket



End plate



Glazing inner gasket 4mm



Glazing inner gasket 6mm



Glazing inner gasket 5mm



Glazing balloon gasket 7mm



Glazing balloon gasket 8mm



Glazing inner gasket 9mm



Fixed lateral cover gasket



Glazing outer gasket 3.6mm



Wool pile



Sealing external gasket

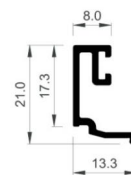

Glazing bead 8mm
Double glazed

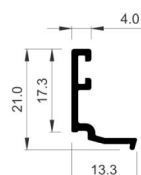

Glazing bead 4mm
Triple glazed

Finish options



Standard profile colours

The Ultimate Evoslide is available as standard in White, Anthracite Grey and Black.

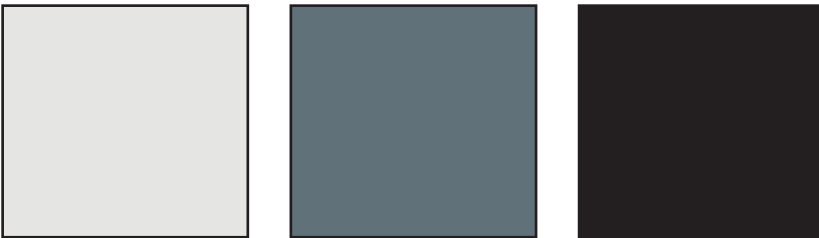

Special Colours

The Ultimate Evoslide is also available in a comprehensive range of colours, single or dual. All colours comprise of a highly durable, powder coated finish to ensure it doesn't lose its splendour over the years. No matter your property style, modern or traditional, an Evoslide is a stunning frame that connects the home with all that's outdoors. Special colours incur an additional charge and lead time.

All finishes come with a 10-year guarantee.



Trickle Ventilators

Optional trickle vents can be included within a 38mm aluminium add-on profile fitted to the top of the frame.

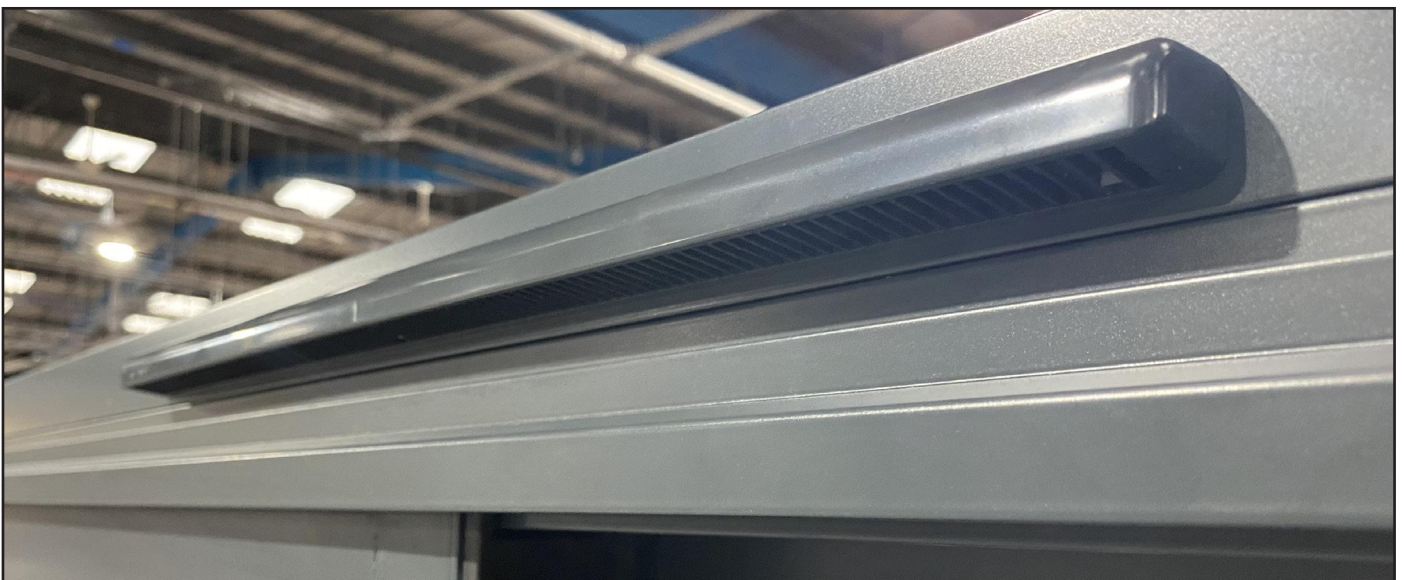

The Ultimate Sliding Doors



- Slim interlock profile of 47mm
- Stainless steel rails that allow for ultra smooth sliding
- Sash heights from 1500mm - 3000mm
- Sash width from 600mm - 2500mm
- Fully assembled from the ground up
- White, Grey and Black standard colours
- Sliding of 2, 3, 4 & 6 sash configurations
- Maximum weight/sash of 280Kg
- 2500+ RAL colour options, single or dual
- Internally glazed accomodating 28mm (double glazed) or 34mm (triple glazed) IGUs
- Optional PAS24 compliant for 2 pane configurations
- Air permeability (EN 12207): Class 3*
- Water tightness (EN 12208): Class 7A*
- Wind resistance (EN 12210): Class C5*
- Regimental Quality Control - every EvoSlide is tested, filmed and fully packaged



The Ultimate
EvoSlide ALUMINIUM PATIO DOORS



Images are for illustrative purposes only

The Ultimate

EvoSlide ALUMINIUM PATIO DOORS

High precision manufacture

We employ the strictest quality management system. This includes fully testing all doors before they leave the factory floor. Fully wrapped and delivered by our dedicated fleet, means that we're able to offer you guaranteed quality and service.

Images shown are for illustration purposes only

OCT2022

